

VARTA Microbattery

mobility for you

SALES PROGRAM AND TECHNICAL HANDBOOK

NICKEL-METAL-HYDRIDE
HIGH PERFORMANCE
RECHARGEABLE BUTTON CELLS

Ni-MH

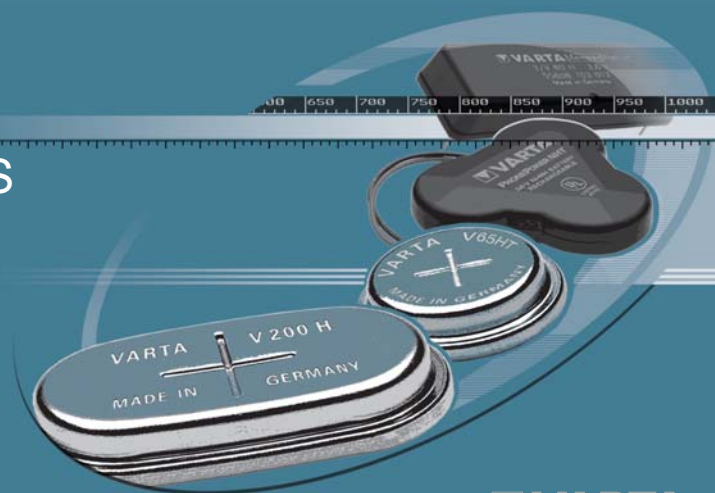

 VARTA

CONTENTS

1. General Information	3–6
1.1 Application Table	4
1.2 General Design and Application Criteria	5
1.3 Construction and Electrochemical Processes of Ni-MH Button Cells	6
2. Assortment	7–13
2.1 Features V...H(T) Range	7
2.2 NI-MH Button Cell Batteries for Memory Protection	8
2.3 NI-MH Button Cell Batteries for Bridging Applications	9
2.4 Standard NI-MH Button Cell Batteries for Telecommunication Applications	10
2.5 Standard NI-MH Button Cell Batteries for Alarm Equipment (Car Alarm, ...)	12
2.6 Standard NI-MH Button Cell Batteries for Electronic Equipment	13
3. Charging/Discharging	14–20
3.1 Charging Methods for NI-MH Button Cells and Batteries in Serial Connection	14
3.2 Recommended Charging Circuits	15
3.3 Charge Table for Ni-MH Button Cells	16
3.4 Typical Charging Curves at Various Temperatures and Rates	17
3.5 Discharge Characteristics of Ni-MH Button Cells	18
3.6 Discharge Diagram of Ni-MH Button Cells	19
3.7 Permissible Temperature Range	20
4. General Characteristics	21–27
4.1 References	21
4.2 Reliability and Life Expectancy	22
4.3 Handling and Safety Guidelines	23
4.4 Battery Assembly	24
4.5 Storage/Handling	25
4.6 Definitions	26
4.7 Application Project Check List	27

Subject to change without further notice. Errors excepted. For latest technical data please refer to our data sheets which you will find on our website www.varta-microbattery.com.

1. GENERAL INFORMATION

VARTA Microbattery is a leading supplier of portable batteries to the OEM and replacement market and provides professional support for our customers with engineered design-in applications worldwide. Quality, reliability, high performance and customer satisfaction are the main reasons for our leading position.

VARTA Microbattery has provided solutions to major OEM companies for high-tech applications in cordless

phones, note-book bridging function, memory backup and real-time clock in PCs/notebooks as well as power source for toys, remote control devices, torches, domestic alarms, car alarms, medical equipment and many more.

With several billion pieces of rechargeable button cells sold to date, you can trust that we have the solution to meet your battery requirements.

SYSTEM HIGHLIGHTS OF Ni-MH BUTTON CELLS FROM **VARTA** Microbattery:

- + Up to 40% more capacity¹⁾
- + No memory effect
- + Long life expectancy at trickle charge:
 - + up to 6 years at 20°C
 - + up to 3 years at 45°C
 - + cycle application (IEC): 1,000 cycles
- + Continuous overcharge capability
- + Low self discharge
- + Limited fast charge possibility (within 3 hours at 0.5 CA, at RT, after full discharge²⁾)
- + Excellent discharge characteristics
- + Wide temperature range
 - + Storage: -40°C up to +65°C
 - + Discharge: -20°C up to +65°C
 - + Charge: 0°C up to +65°C
 Therefore suitable for standard, high temperature and trickle charge applications
- + Direct replacement for Ni-Cd button cells
- + 0% lead, 0% mercury and 0% cadmium
- + UL recognition
- + ISO 9000 certified for design and manufacture of rechargeable mass type cells and batteries. Conformity to requirements of ISO 9001
- + **VARTA** Microbattery is a leader of Ni-MH Button Cell technology and received several ecological and industry awards.

¹⁾ Than standard nickel-cadmium batteries

²⁾ Not applicable to V 200 H, V 350 H

ENERGY DENSITY FOR RECHARGEABLE BATTERY SYSTEMS

FIG. 1

Comparison of different rechargeable battery systems



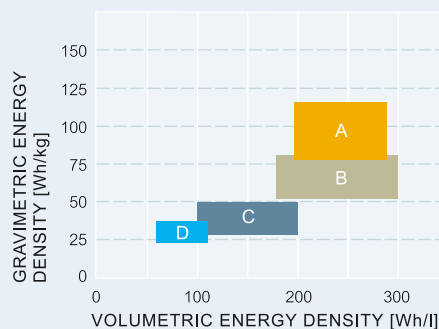

A = Lithium-Ion
B = Ni-MH
C = Ni-Cd
D = Lead



1.1 APPLICATION TABLE

The Ni-MH High Performance Button Cell generation from **VARTA** Microbattery is suitable for a wide application spectrum in addition to the main 3-C applications (Com-

munication products, Computers, Consumer electronics). Here are examples for memory backup (MBU) real-time clock (RTC) and power supply applications.

Applications	V 15 H	V 40 H	V 80 H	V 150 H	V 200 H	V 250 H	CP 300 H	V 350 H	V 65 HT	V 110 HT
Communication products										
 Portable/mobile cellular phones, cordless phones, portable radio equipment, transmitters, transceivers, pager, etc.				+	+		+	+		
Computers										
 Laptops, Desktop-PC's, notebooks, PDA's, etc. for MBU, RTC and bridging	+	+	+							
Consumer electronics										
 Camcorders, video TV sets, car stereo, Hi-Fi, photo, memory backup etc.	+	+	+	+						
Devices for industry, office and household peripherals, etc.										
 Measuring devices, medical equipment			+	+		+	+		+	+
Industrial clocks		+	+						+	+
Emergency signalling and warning equipment, alarm equipment				+	+	+	+			
Fax machines, printers, copiers, data acquisition terminals	+	+	+	+					+	+
High temp. memory protection, on-board car computers/car alarm			+	+	+	+	+		+	+
Pocket radios, radio microphones		+	+	+						
Tea and coffee machines	+	+								
Rechargeable torches				+	+	+	+			
Calculators, solar watches, hearing aids	+	+								
Games, toys, model construction				+		+	+			
Radio controlled headphones			+							

TAB. 1
Applications for Ni-MH Button Cells/Batteries

1.2 GENERAL DESIGN AND APPLICATION CRITERIA

The choice of the most suitable cells or battery types is exclusively related to the type of application and the precise operating conditions.

THE MOST IMPORTANT CRITERIA FOR SELECTION ARE AS FOLLOWS:

- + Type of operation of the cell, i.e. cyclic operation (continuous sequence of charge/discharge processes) or standby operation, trickle charged
- + Space available
- + Maximum permissible weight
- + Temperature during use
- + Duration and level of load (continuously/pulse)
- + Operating voltage required with voltage limiting values
- + Charging conditions

The relevant data can be found in the corresponding sections of this catalogue. The data comprises standard values for planning purposes. As such they describe the minimum performance for each cell type and always refer to single cells.

For the assembly of batteries, care should be taken to ensure that the technical data provided for single cells is modified by the requirement to consider variations in individual cell capacities, voltage drop due to leads and connections, and the actual temperature in the interior of the batteries. In summary, single cell data must be adjusted when battery assembly is required.

Attention should be expressly drawn to the fact that only cells of the same manufacture and design should be assembled into batteries.

Standard battery assemblies up to 10 cells (12 V nominal voltage) are available.

Assemblies with higher numbers of cells are possible under certain application conditions. Ask us – we will advise you.

For further orientation and planning, please find a check list on page 27 of this handbook.

1.3 CONSTRUCTION AND ELECTROCHEMICAL PROCESSES OF Ni-MH BUTTON CELLS

A specially constructed seal, with long diffusion path, creates an excellent seal. The cup of the casing acts as the positive terminal and the lid as the negative terminal. The punched positive sign on the cell is used as a safety device which opens at predetermined internal pressure, in case of gross abuse. Some cells are interchangeable with 1.5 V primary cells of identical dimensions.

A sealed Ni-MH Button Cell requires that towards the end of charging, oxygen which is generated at the positive electrode must be consumed to avoid pressure build-up (charge reserve). Additionally a discharge reserve is necessary to prevent degradation of the negative electrode at the end of discharge. In general the negative electrode is overdimensioned compared with the positive, which determines the usable cell capacity. (Fig. 3)

FIG. 2

Schematic view of a Ni-MH Button Cell

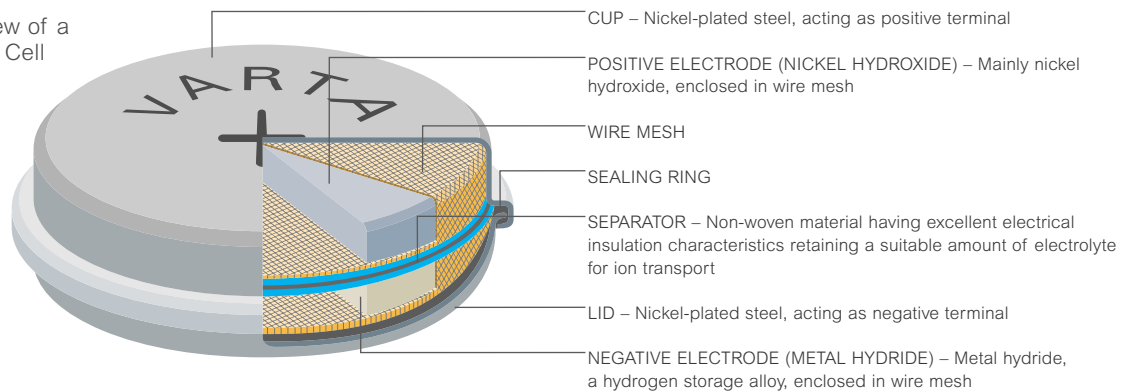

CHEMICAL PROCESS OF CHARGING/DISCHARGING

$Ni(OH)_2 + Metal$	Charging Discharging	$NiOOH + MH$
Charge product of the positive electrode:		Nickel (III) oxyhydroxide – NiOOH
Charge product of the negative electrode:		Metal hydride
Discharge product of the positive electrode:		Nickel (II) hydroxide – Ni(OH) ₂
Discharge product of the negative electrode:		Metal alloy
Electrolyte:		Alkaline solution (KOH)

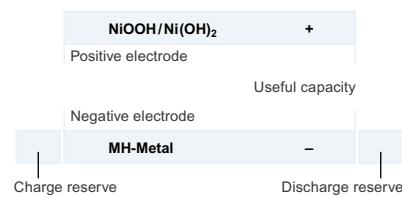

FIG. 3

Schematic representation of the electrodes, demonstrating useful capacity, charge reserve and discharge reserve

2. ASSORTMENT

2.1 FEATURES V... H(T) RANGE

- + Cells with typical capacities from 16 up to 380 mAh
- + Nominal cell voltage 1.2 V
- + Wide operating temperature range
- + Built-in safety device
- + UL Recognition
- + Limited fast charge possible (within 3 h at 0.5 CA, at +20°C, after fully discharged cells)
- + Suitable for overcharging at room temperature
- + Long life expectancy
- + Self-discharge less than 10% after 1 month at +20°C
- + High temperature range V... HT
 - + High capacity
 - + Long life expectancy especially at charging/trickle charging and discharging at higher ambient temperature



Technical Data	V 15 H	V 40 H	V 80 H	V 150 H	V 200 H	V 250 H	CP 300 H	V 350 H	V 65 HT	V 110 HT (V 150HT)*
Order Number	55602 101 501	55604 101 501	55608 101 501	55615 101 501	55620 101 501	55625 101 501	55630 101 501	55635 101 501	55707 101 501	55711 101 501
Typ. Capacity (mAh)	16	43	80	150	210	250	300	380	70	120 (150)*
Nominal Voltage (V)	1.2	1.2	1.2	1.2	1.2	1.2	1.2	1.2	1.2	1.2
Nom. Capacity (mAh)	15	40	70	140	200	240	280	350	65	110 (140)*
Dimension										
Diameter/Length (mm)	11.5 -0.1	11.5 -0.2	15.5 -0.1	25.6 -0.2	25.6 -0.15	25.1 -0.15	25.1 -0.15	25.1 -0.15	15.5 -0.2	25.6 -0.2
Height (mm)	3.1 -0.2	5.35 -0.3	6.0 -0.2	5.85 -0.25	7.4 -0.25	6.7 -0.6	7.55 -0.6	8.8 -0.6	6.0 -0.3	5.85 -0.25
Width (mm)	–	–	–	14.1 -0.2	14.1 -0.2	–	–	–	–	14.1 -0.2
Weight, approx. (g)	1.3	1.7	4	6	7	10	11	13	4	6
Charge Method										
Normal Charging Current	1.5	4	7	14	20	24	28	35	6.5	11
for 14–16 h (mA)										
Accelerated Charging	3	8	14	28	40	48	56	70	13	22
for 7–8 h (mA)										
Limited Fast Charge ¹⁾ for 3 h (mA)	7.5	20	35	70	–	120	140	–	32.5	55
Trickle Charge (mA)	0.45	1.2	2.1	4.2	6.0	7.2	8.4	10.5	1.95	3.3
Overcharge Current at 20°C										
For Continuous (mA)	1.5	4	7	14	20	24	28	35	6.5	11
Max. 1 year (mA)	3.0	8	14	28	40	48	56	70	13	22
Self-discharge (1 month storage, 20°C)	< 10%	< 10%	< 10%	< 10%	< 10%	< 10%	< 10%	< 10%	< 10%	< 10%
Operating Temperature										
Charging	0 to 65°C	0 to 65°C	0 to 65°C	0 to 65°C	0 to 65°C	0 to 65°C	0 to 65°C	0 to 65°C	0 to 80°C	0 to 65°C (80°C)*
Discharging	-20 to 65°C	-20 to 65°C	-20 to 65°C	-20 to 65°C	-20 to 65°C	-20 to 65°C	-20 to 65°C	-20 to 65°C	-20 to 80°C	-20 to 65°C (80°C)*
Storage	-40 to 65°C	-40 to 65°C	-40 to 65°C	-40 to 65°C	-40 to 65°C	-40 to 65°C	-40 to 65°C	-40 to 65°C	-40 to 80°C	-40 to 65°C (80°C)*
Life Expectancy (typical)										
IEC Cycles	1000 cycles	1000 cycles	1000 cycles	1000 cycles	1000 cycles	1000 cycles	1000 cycles	1000 cycles	1000 cycles	1000 cycles
Trickle Charge at 20°C	up to 6 years	up to 6 years	up to 6 years	up to 6 years	up to 6 years	up to 6 years	up to 6 years	up to 6 years	up to 6 years	up to 6 years
Trickle Charge at 45°C	up to 3 years	up to 3 years	up to 3 years	up to 3 years	up to 3 years	up to 3 years	up to 3 years	up to 3 years	up to 5 years	up to 5 years
Impedance/Internal Resistance²⁾										
Impedance (mOhm) ³⁾	490	420	220	130	140	70	80	80	220	180
Internal Resistance (Ohm) ⁴⁾	4.03	3.05	1.30	0.8	0.8	0.46	0.47	0.47	1.25	1.00

TAB. 2

¹⁾ After full discharge. Limited fast charge must be limited to room temperature, time controlled, voltage control recommended (except V 200 H, V 350 H). ²⁾ In accordance to IEC 61951-2, measured at charged cells at room temperature. Tolerance $\pm 10\%$. ³⁾ AC at 1 kHz ⁴⁾ DC at 0.2 CA/2 CA *available 2. half of 2004

2.2 NI-MH BUTTON CELL BATTERIES FOR MEMORY PROTECTION

MBU/RTC BATTERIES

These batteries are designed for memory backup (MBU) and support to RTC (Real Time Clock) in various electronic applications. Ni-MH Button Cell Batteries in the charged state are suitable for wave soldering ($t_{\max.} = 10 \text{ sec.}$, $T_{\max.} = 265^\circ\text{C}$). For further information on other Ni-MH Button Cell Batteries for memory protection please consult **VARTA** Microbattery.

USUAL USE, E. G. FOR:

- + PC
- + Desktop PC's
- + Notebooks
- + VCR
- + Car stereo, etc.

Type	No. of cells	Order No.	Nominal voltage (V)	Typical capacity (mAh)	Nominal capacity (mAh)	Length (mm)	Width (mm)	Height without pins (mm)	Weight (g)
Mempac S-H									
3/V 15 H	3	55602 703 012	3.6	16	15	42.4 -0.6	17.0 -0.4	10.5 -1	7
1/V 150 H	1	55615 701 012	1.2	150	140	42.4 -0.6	17.0 -0.4	10.5 -1	9
2/V 150 H	2	55615 702 012	2.4	150	140	42.4 -0.6	17.0 -0.4	16.0 -1	15
3/V 150 H	3	55615 703 012	3.6	150	140	40.3 -0.6	22.2 -0.4	16.0 -1	21
Mempac Flat-H									
2/V 80 H	2	55608 702 012	2.4	80	70	37.0 -0.3	20.0 -0.3	10.0 -1	10
3/V 80 H	3	55608 703 012	3.6	80	70	55.0 -0.3	20.0 -0.3	10.0 -1	15
Popular Memory Backup Batteries for PC									
3/V 15 H	3	55602 303 015 ¹⁾	3.6	16	15	10.6 -1	12.4 -0.5	12.4 -0.5	4
2/V 40 H	2	55604 302 059 ²⁾	2.4	43	40	11.0 -1	12.0 -0.5	12.0 -0.5	6
3/V 40 H	3	55604 303 059 ²⁾	3.6	43	40	16.8 -1.5	12.0 -0.5	12.0 -0.5	8
2/V 80 H	2	55608 303 012 ¹⁾	2.4	80	70	13.6 -2.2	16.0 -0.5	16.0 -0.5	10
3/V 80 H	3	55608 303 059 ²⁾	3.6	80	70	19.0 -1	16.0 -0.5	16.0 -0.5	15

TAB. 3⁻⁻⁻

Series Mempac S-H, Mempac Flat-H and other standard batteries (for temperature up to +65°C)

¹⁾ Stack in shrink sleeve, with solder tags (2 pins) ²⁾ Stack in shrink sleeve, with solder tags (3 pins)



2/V 40 H
(stack in plastic case)



3/V 40 H



3/V 80 H



Mempac Flat Series



Mempac Series

2.3 NI-MH BUTTON CELL BATTERIES FOR BRIDGING APPLICATIONS

BRIDGING BATTERIES

Bridging batteries from **VARTA** Microbattery are optimised in small size and provide high power output for bridging mobile computers e.g. during main battery change. Bridging batteries temporary take over the supply of DRAM and other chips in notebooks, PC's, palmtops, calculators, etc. when the main battery is replaced within a certain time frame specified by the manufacturer.

USUAL USE, E. G. FOR:

- + Notebooks
- + Palmtops
- + Calculators

A TYPICAL REQUIREMENT FOR EXAMPLE IS THIS:

- + Charging current: 0.1CA (+0.03 CA) continuous
- + Discharge current: 30–100 mA¹⁾
- + Bridging time: 5–15 min.
- + Operating temperature: 0–45 °C

¹⁾ Proper selection of battery capacity is required.

Type	No. of cells	Order No.	Nominal voltage (V)	Typical capacity (mAh)	Nominal capacity (mAh)	Length (mm)	Width (mm)	Height without pins (mm)	Weight (g)	Wire length (mm)
Ni-MH Batteries for Bridging Applications										
6/V 15 H	6	55602 406 018 ¹⁾	7.2	16	15	72.0	14.5	4.5	10	30
6/V 40 H	6	55604 406 012 ¹⁾	7.2	43	40	70.5	14.0	7.0	12	65
6/V 80 H	6	55608 406 012 ¹⁾	7.2	80	70	94.0	17.0	8.0	26	60

TAB. 4

¹⁾ Layflat version with wires and connector. Other configurations available on request.



6/V 15 H
(layflat version)



6/V 40 H
(3x2 layflat version)



6/V 80 H
(3x2 stack up version)

2.4 STANDARD NI-MH BUTTON CELL BATTERIES FOR TELECOMMUNICATION APPLICATIONS

PHONEPOWER NHT AND NHS

- + Button cell batteries for cordless telephones
- + Nominal voltage 3.6 V
- + Temperature range:
 - + Charging: 0°C to +65°C
 - + Discharging: -20°C to +65°C
 - + Storage: -40°C to +65°C
- + Suitable for long overcharging at room temperature
- + Limited fast charge possibility
- + Life expectancy (IEC): 1,000 cycles
- + Trickle charge applications: Typical life expectancy at room temperature: 3 to 6 years
- + Professionally assembled in plastic casing (PhonePower NHT, CP 2010 H)
- + Built-in safety devices (designed to operate safely in event of reasonably foreseeable abuse)
- + Fulfill all standard cordless telephone application requirements
- + UL Listing MH 16707 (N): PhonePower NHT

USUAL USE, E. G. FOR:

- + Cordless telephones
- + Pagers
- + Transmitters

FIG. 4

Discharge diagram PhonePower NHT and NHS (CP 300 H)

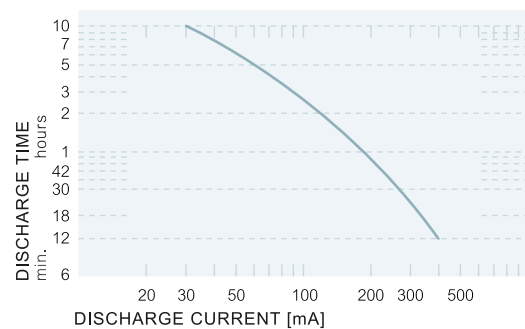

Type	No. of cells	Order No.	Typical capacity (mAh), 5 hours	Nominal capacity (mAh), 5 hours	Discharge current (mA), 0.2 CA	Standard charge current (mA)	Charge duration (h)	Length/Diameter (mm)	Width max. (mm)	Height max. (mm)	Weight (g)
Ni-MH Batteries for Telecommunication Applications											
CP2010H	3	55620 703 ... ¹⁾	210	200	40	20	14–16	42.5	31.0	16.0	28
3/V 200 H	3	55620 403 ... ²⁾	210	200	40	20	14–16	44.0	30.0	11.0	23
PhonePower NHT	3	55630 703 ... ³⁾	300	280	56	28	14–16	48.0	52.0	10.6	36
PhonePower NHS	3	55630 303 ... ⁴⁾	300	280	56	28	14–16	26.0		32.0 ⁵⁾	36
3/CP 300 H	3	55630 903 ... ⁶⁾	300	280	56	28	14–16	51.0	26.0	17.5	36
3/V 350 H	3	55635 403 013 ⁷⁾	380	350	70	35	14–16	77.0	27.0	9.4	40

TAB. 5

¹⁾ Available with different connectors: 55620 703 012: Molex 5264-02 (wire length 25 mm); 55620 703 013: JST EHR-2 (wire length 25 mm); 55620 703 014: Mitsumi M63 (wire length 25 mm) ²⁾ Available with different connectors: 55620 403 012: Molex 5264-02 (wire length 25 mm); 55620 403 013: JST EHR-2 (wire length 25 mm); 55620 403 014: Mitsumi M63 (wire length 25 mm) ³⁾ Available with different connectors: 55630 703 012: Mitsumi M63 (wire length 55 mm); 55630 703 014: Molex 51005-02 (wire length 70 mm); 55630 703 016: JST EHR-2 (wire length 50 mm) ⁴⁾ Available with different connectors: 55630 303 013: Mitsumi M63 (wire length 60 mm); 55630 303 014: Molex 51005-02 (wire length 70 mm); 55630 303 019: JST EHR-2 (wire length 50 mm) ⁵⁾ With wire/connector: max. 32.0 mm, with ring tag: max. 29.0 mm ⁶⁾ Available with different connectors: 55630 903 014: JST EHR-2 (wire length 50 mm); 55630 903 015: Mitsumi M63 (wire length 48 mm); 55630 903 012: Molex 5264 (wire length 40 mm) ⁷⁾ With Molex 51004 connector

Different connectors available on request.



FIG. 5A

Self-discharge characteristics of PhonePower NHT and NHS

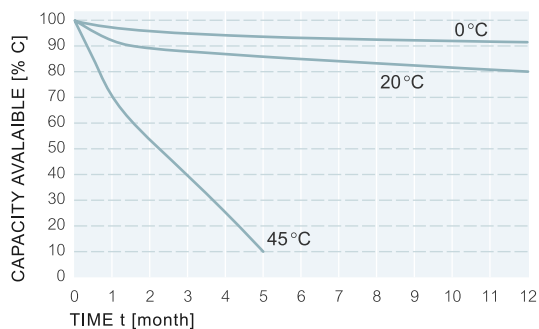
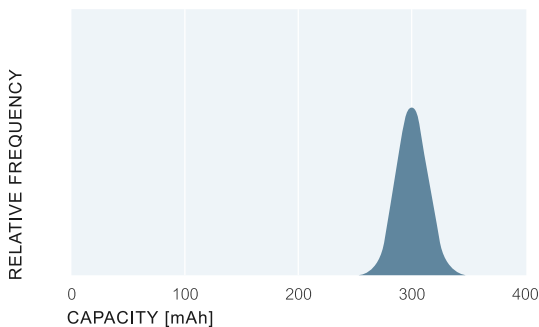

FIG. 5B

Typical capacity distribution of PhonePower NHT and NHS (Discharge at 56 mA)



2.5 STANDARD NI-MH BUTTON CELL BATTERIES FOR ALARM EQUIPMENT (CAR ALARM, ...)

ALARM BATTERIES

Reliable **VARTA** Microbattery Alarm Batteries with high capacity supply power for alarm signals as back up or main battery. **VARTA** Microbattery offers suitable solutions for all different alarm equipments (piezzo, electro-magnetic loudspeakers, ...).

USUAL USE, E. G. FOR:

- + Car alarm equipment
- + Domestic alarm equipment

Type	No. of cells	Order No.	Nominal voltage (V)	Typical capacity (mAh), 5 hours	Nominal capacity (mAh), 5 hours	Discharge current (mA), 0.2 CA	Charge current (mA), 14–16 hours	Dimensions (mm), l/b	Width (mm)	Height (mm)	Weight (g)
Ni-MH Batteries for Alarm Equipment											
6/V 150 H	6	55615 306 060	7.2	150	140	28	14	max. 26.5	15.0	max. 37.8	41
6/V 200 H	6	55620 306 060	7.2	210	200	40	20	max. 26.5	15.0	max. 46.5	45
6/V 250 H	6	55625 306 060	7.2	250	240	48	24	25.8	–	40.7	65
6/V 250 H	6	55625 906 012	7.2	250	240	48	24	52.0	48.0	14.7	65
6/V 250 H	6	55625 906 014	7.2	250	240	48	24	52.0	48.0	14.7	65

TAB. 6

Further car alarm batteries in different configurations from 4.8 V up to 10.8 V are available. Please contact **VARTA** Microbattery



6/V 150 H



6/V 200 H



6/V 250 H



6/V 250 H



6/V 250 H

FIG. 6

Discharge curve for car alarm application with a horn.
Discharge of 6/V 250 H with 4 Ohm horn and typical discharge voltage and discharge current characteristics.

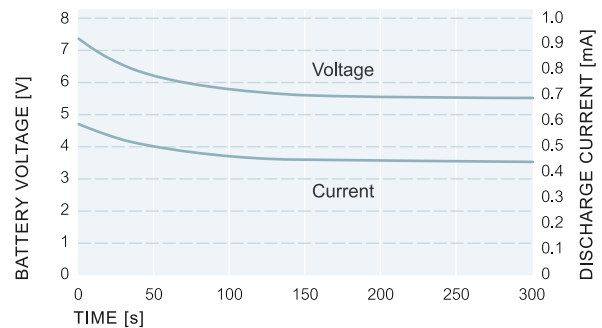

2.6 STANDARD NI-MH BUTTON CELL BATTERIES FOR ELECTRONIC EQUIPMENT

V7/8 H BLOCK BATTERY "9V"

This button cell battery V7/8H is suitable for applications in many electronic equipment (assembled from 7 pieces of V 150 H cells).

USUAL USE, E. G. FOR:

- + Pocket radios
- + Portable telephones
- + Electronic calculators
- + Cordless microphones
- + Remote controls
- + Medical instruments
- + Scientific instruments
- + Toys

- + Nominal voltage 8.4 V
- + Temperature range:
 - + Charging: 0 °C to +65 °C
 - + Discharging: -20 °C to +65 °C
- + Accelerated chargeable with 28 mA within 7–8 hours at 20 °C
- + Endurance (IEC) up to 1,000 cycles
- + Additional special contact plate¹⁾ at the positive stud
- + Battery size is compatible with primary 9V-block battery and conforms with IEC 6 F 22, 6 LR 61.

NOTE: For further information see also V 150 H. (page 7)

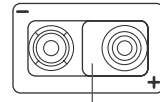

Contact plate¹⁾

¹⁾ This contact plate is a feature to prevent charging primary 9V-block. We recommend this to be adopted at charger designs.

Type	No. of cells	Order No.	Nominal voltage (V)	Typical capacity (mAh), 5 hours	Nominal capacity (mAh), 5 hours	Discharge current (mA), 0.2 CA	Standard charge current (mA)	Charge duration (h)	Length max. (mm)	Width (mm)	Height (mm)	Weight (g)
Ni-MH Batteries for Electronic Equipment												
V7/8 H ¹⁾²⁾	7	05622 101 052	8.4	150	140	28	14	14–16	26.5	17.5–0.7	48.5–1	47

TAB. 7

¹⁾ Interchangeable for primary 9V-block batteries 6F22 or 6LR61 e.g. VARTA Microbattery types 3022, 3722, 4022 or 4722, UL-Recognition: No. MH 13654 (N), Type of connector: Crown contacts DUF 3 1/4, suitable for double plug ²⁾ Version V6/8H (7.2 V) available in USA

FIG. 7 Discharge characteristics of V7/8H

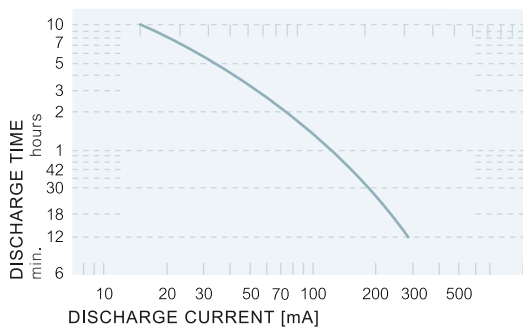
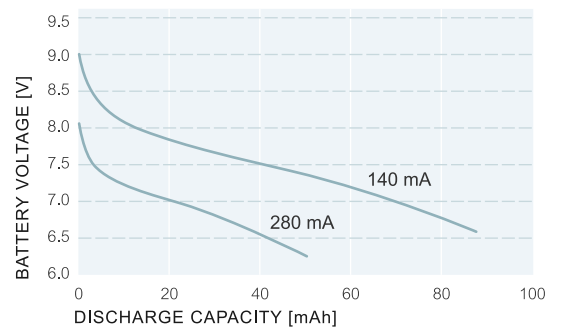

FIG. 8 Discharge curves of V7/8H



3. CHARGING/DISCHARGING

3.1 CHARGING METHODS FOR NI-MH BUTTON CELLS AND BATTERIES IN SERIAL CONNECTION

The most suitable method to fully charge sealed rechargeable Ni-MH Button Cells is the constant current charge for a timed period.

STANDARD CHARGE

Applicable for all Ni-MH Button Cell series. Charging is with constant current: 14–16 hours at 0.1 CA.

Occasional overcharging at the nominal charge current (see page 16) is permissible.

In special cases, a 24 hour charge at the nominal current is recommended, to achieve or restore the full performance of the cell or battery. This is a normal measure for:

- + First charge to put into operation
- + First recharge after prolonged storage
- + Deep-discharged cells and batteries, particularly those which have been discharged into reverse unintentionally

ACCELERATED CHARGE

Accelerated charge means charging 7–8 hours at 0.2 CA. It is recommended that charging is controlled by means of a timer.

LIMITED FAST CHARGE WITH VOLTAGE CONTROL¹⁾

Ni-MH Button Cells can be fast charged with the charge rate, specified for each cell. Because of the specific charge current values this is called a limited fast charge (0.5 CA). It is possible to recharge more than 80% of the nominal capacity within 3 hours. Charging must be terminated after 3 hours. The cells must be fully discharged before charged with this method. Limited fast charge is recommended only at room temperature application.

TRICKLE CHARGE

Ni-MH Button Cells are also suitable for trickle charging. A large number of applications need the use of cells or batteries which are kept at all times in a fully charged state to guarantee an emergency power supply or a standby operation.

To correctly specify a suitable constant charge current regime the following criteria apply:

- + Maximum permissible trickle charge current (see page 16)
- + Adjustment of the losses of capacity resulting from self-discharge
- + Consideration of the charging efficiency as a function of the temperature and charge current
- + Minimum recharge time from full discharge

To compensate the constant losses by self-discharge and to be able to recharge a discharged battery, for example due to a mains failure, a trickle charge current of 0.03 CA is recommended.

At this charge rate a life of up to 6 years (at room temperature) is to be expected. A reasonable reduction in life expectancy must be considered, when the battery will be overcharged at the max. permitted over-charge current.

INTERMITTENT TRICKLE CHARGE

Ni-MH Button Cells can also be charged with this method. As the specified trickle charge is insufficient to fully charge a discharged battery at high temperatures and a constant overcharge at the specified rate or higher limits the life, a modified charging method can be adopted.

The following conditions must be observed:

- + Charging of the discharged battery should take place time-controlled with a high rate possible, e.g. 0.2 CA, to recharge the battery quickly after a mains failure
- + The following trickle charge should only cover the losses due to self-discharge and stabilise the available capacity

For this purpose a two-step charge is applied, one to fully charge the battery and a second to equalize the battery. The first charge is terminated by a simple timer circuit.

After every discharge of the battery, regardless of the duration, a full charge is applied, e.g. charging for 7 to

8 hours at 0.2 CA. The trickle charge is however different from the previous methods and takes place at intervals. It is recommended that the intervals last at least 1 minute per hour and are at the accelerated charge rate, e.g. 0.1 to 0.2 CA.

In the interest of the life of the battery, however, no more than 10% of the nominal capacity should be recharged per day. This is sufficient to recover completely any losses due to self-discharge.

While the component cost for the electronic timing

control is not excessive, the necessary transformer for full charge may not be available in every case. Compromises are therefore necessary and may lead, for example, to the reduction of the charge rate in the full charge stage to 0.1 CA.

NOTE: Charging of cells connected in parallel must be avoided (if this cannot be avoided blocking by diodes is recommended).

¹⁾ Except V 200 H, V 350 H

3.2 RECOMMENDED CHARGING CIRCUITS

STANDARD/ACCELERATED CHARGE

Charge circuit for charging cells/batteries at constant current at normal charge and accelerated charge. The charge process has to be interrupted by a timer at the end of the charging period.

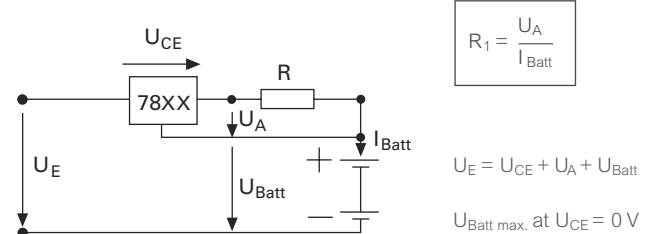

FIG. 9

TRICKLE CHARGE

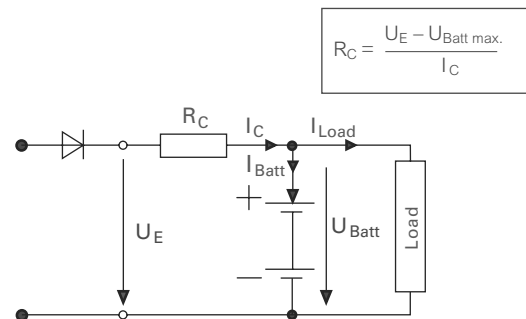

FIG. 10

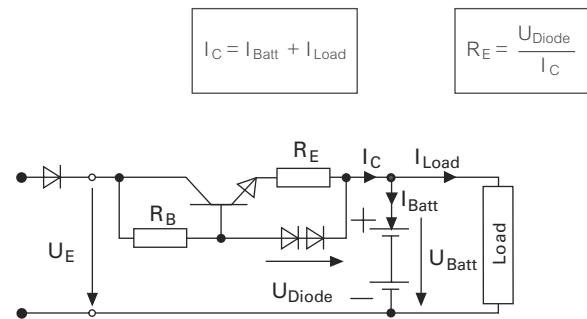

FIG. 11

3.3 CHARGE TABLE FOR Ni-MH BUTTON CELLS

CHARGE TABLE

	Normal charge	Accelerated charge	Limited fast charge ¹⁾	Trickle charge	Max. possible overcharge capability ²⁾
Specific currents	0.1 CA	0.2 CA	0.5 CA	0.01 CA to 0.03 CA	–
Charge time	14–16 hours	7–8 hours	3 hours	unlimited	–
Recommended charging values at room temp. for the series V...H(T)	0.1 CA 14–16 hours	0.2 CA 7–8 hours preferably time controlled	0.5 CA 3 hours time and voltage ³⁾ controlled	0.01 CA to 0.03 CA unlimited	0.1 CA for unlimited period at 20 °C. 0.2 CA for max. 1 year at +20 °C
Available capacity (%)	100	100	> 80	100	> 80

TAB. 8

¹⁾ Only at room temperature and after fully discharged cells, voltage control recommended (except V 200 H, V 350 H) ²⁾ Reduction of life expectancy ³⁾ For specific cut off voltage ask **VARTA** Microbattery

NOTE: Ni-MH Button Cells shall not be charged at temperatures below 0 °C

FIG. 12 Typical Trickle Charging

Figure 12 shows at a typical trickle charging circuit battery voltage and charge current characteristic versus charging time for a two cell battery

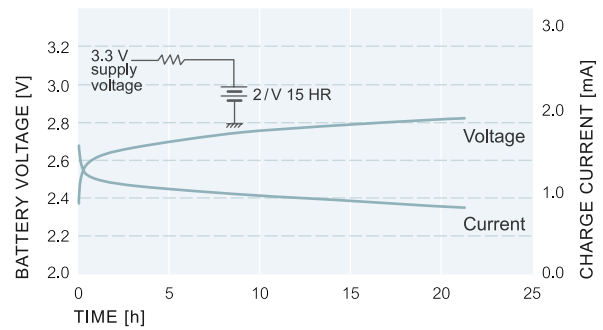

3.4 TYPICAL CHARGING CURVES AT VARIOUS TEMPERATURES AND RATES

FIG. 13

Charging curves at various charging currents of Ni-MH Button Cells
V... H(T) at +23°C

A = 0.2 CA
B = 0.1 CA
C = 0.050 CA
D = 0.033 CA
E = 0.010 CA

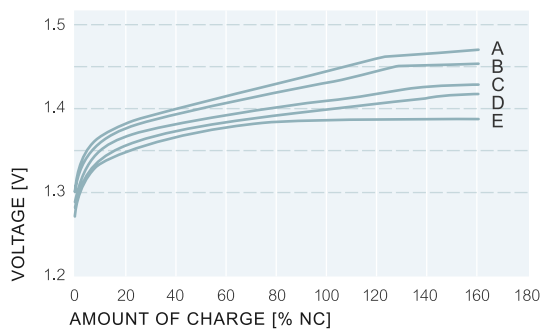

FIG. 14

Charging curves at various charging currents of Ni-MH Button Cells
V... H(T) at +45°C

A = 0.1 CA
B = 0.050 CA
C = 0.033 CA
D = 0.010 CA

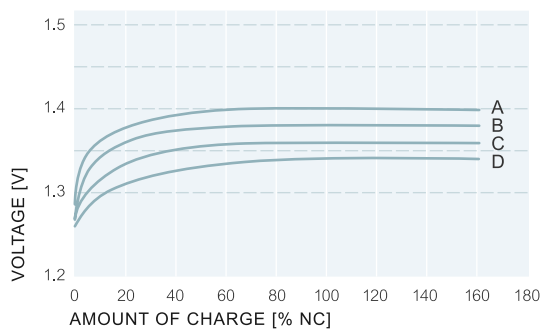
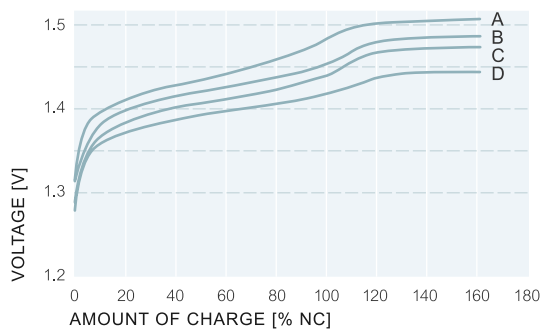

FIG. 15

Charging curves at various charging currents of Ni-MH Button Cells
V... H(T) at 0°C

A = 0.1 CA
B = 0.050 CA
C = 0.033 CA
D = 0.010 CA



3.5 DISCHARGE CHARACTERISTICS OF Ni-MH BUTTON CELLS

The capacity and the voltage level of a cell during discharge are limited by various operational parameters. The most important of these are: the rate of discharge, the ambient temperature and the end of discharge

voltage. In general, the higher the discharge current, the lower the discharge voltage and the available capacity; this tendency becomes pronounced when the discharge current reaches 2 CA.

FIG. 16

Discharge curves of Ni-MH Button Cells at various continuous loads

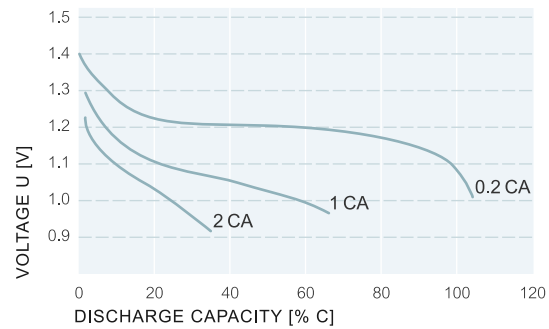

Typical discharge curves of Ni-MH Button Cells at +23°C

FIG. 17

Discharge curves of Ni-MH Button Cells V...H(T) at various temperatures

- A = -20°C
- B = 0°C
- C = 20°C
- D = 50°C
- E = 65°C

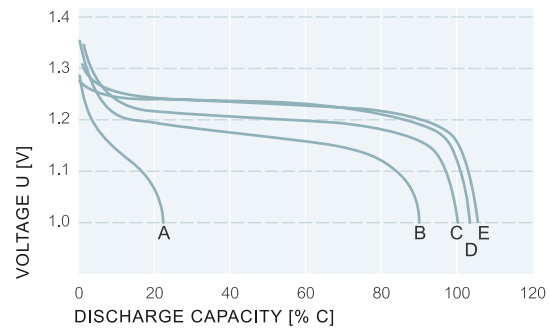

Charge: 0.1 CA for 16 hours at room temperature
Discharge: 0.2 CA to 1 V at respective temperature

FIG. 18

Relative capacities, based on the effective capacity (= 100% C at room temperature) as a function of the discharge temperature at 0.2 CA

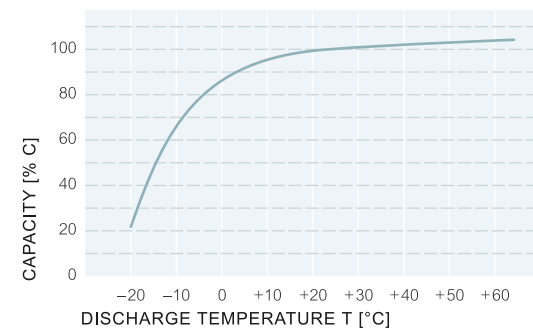

Charge: 0.1 CA, 16 hours at room temperature
Discharge: 0.2 CA to 1 V at various temperature

3.6 DISCHARGE DIAGRAM OF NI-MH BUTTON CELLS

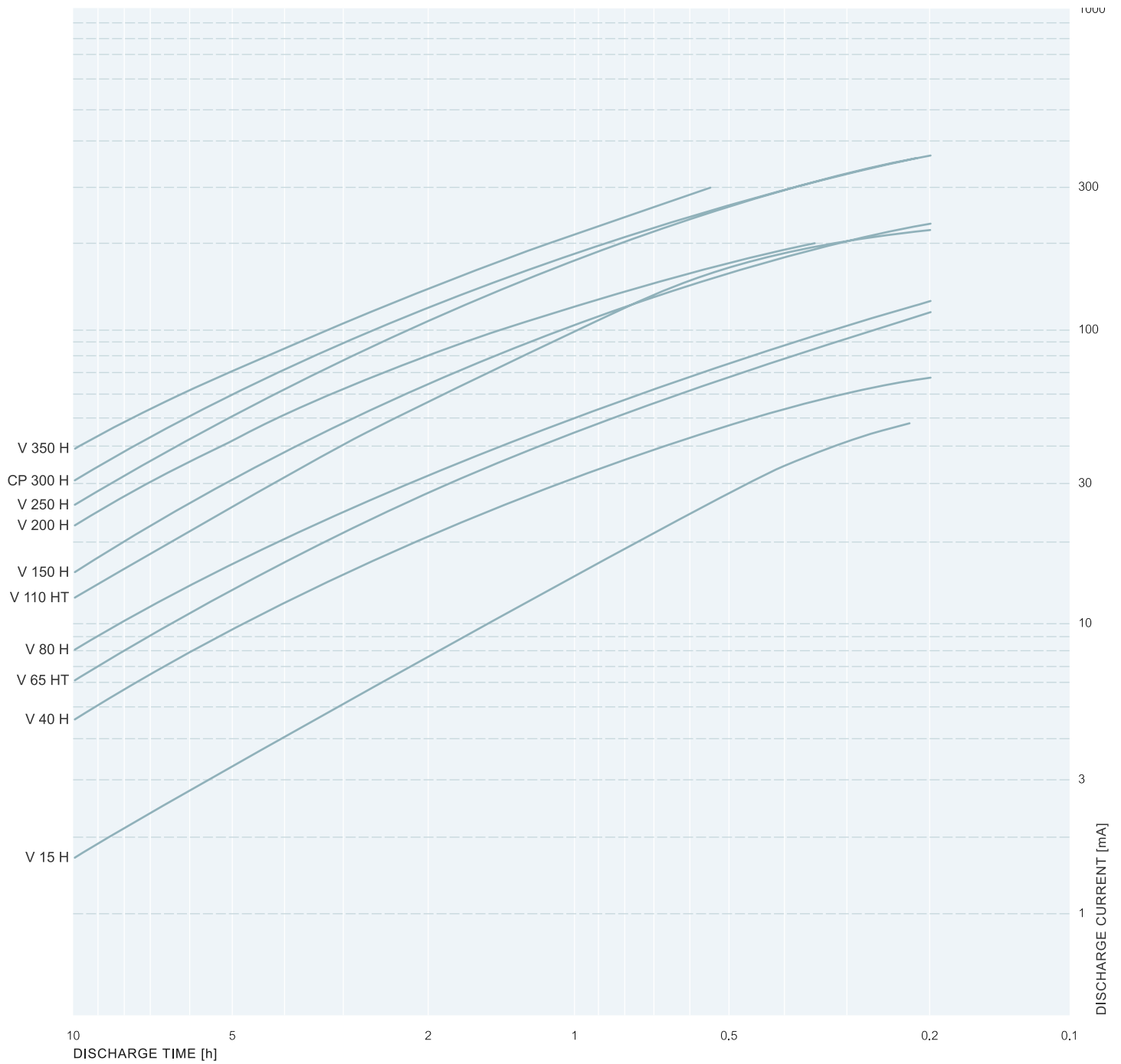

FIG. 19

Discharge diagram for selection of Ni-MH Button Cells Series V...H(T)
(T = +20°C, based on nominal capacity)

3.7 PERMISSIBLE TEMPERATURE RANGE

The Ni-MH Button Cells from **VARTA** Microbattery have a wide temperature range, therefore they are suitable for standard and high temperature and trickle charge applications.

OPERATION TEMPERATURE DURING CHARGE

Charge efficiency is very dependent on the operating temperature. Due to the increasing evolution of oxygen at the positive electrode, charge efficiency decreases at higher temperatures. At low temperatures charge efficiency is excellent due to decreasing oxygen evolu-

tion. As the oxygen recombination process is slowed down at low temperature, a certain rise in internal cell pressure may occur depending on charge rate. The ranges of operation temperatures in Fig. 20 are permitted.

OPERATION TEMPERATURE DURING DISCHARGE

Maximum capacity is obtained at an ambient temperature of about +20°C. There is a slight decrease of capacity at higher and lower temperatures especially at a longer period of time. This reduction in capacity is more pronounced at low temperatures and high discharge rates.

SERIES V...H(T)

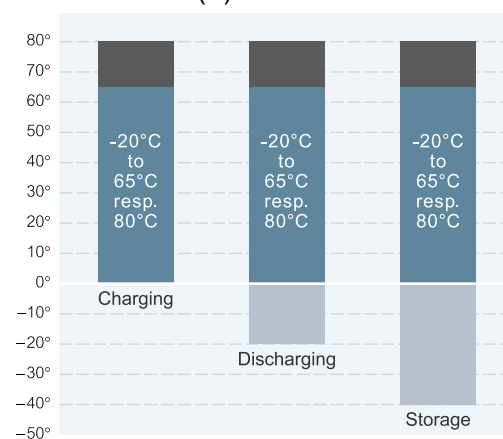

FIG. 20

Permissible temperature range for Ni-MH Button Cells (65°C resp. 80°C depending on type. See also p.7)

NOTE: At temperatures below 0°C max. discharge current ≤ 0.2 CA

CHARGE RETENTION (SELF-DISCHARGE)

Due to the self-discharge of the cells the stored capacity decreases over time. The self-discharge is dependent on temperature. The higher the temperature, the greater the self-discharge over time. Losses in capacity due to self-discharge are reversible. After long-term storage (e.g. more than one year at room temperature) up to three full cycles may be necessary to obtain full capacity.

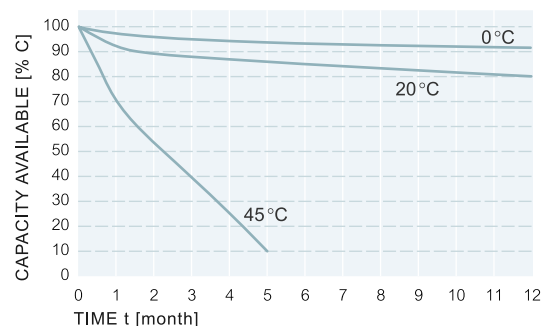

FIG. 21

Self-discharge characteristics at different temperatures

4. GENERAL CHARACTERISTICS

4.1 REFERENCES

Ni-MH Button Cells from **VARTA** Microbattery (made in Germany) are produced in an outstanding quality level at ISO 9001 certified facilities on fully automated lines. Process control in combination with various internal and external tests, e.g. UL recognition tests, give our customers the highest reliability and safety for their

UL RECOGNITION

Currently the following Ni-MH Button Cells and batteries from **VARTA** Microbattery are recognized by Underwriters Laboratories Inc. under UL file number MH 13654 (N): V 15 H, V 40 H, V 80 H, V 110 HT, V 150 H, V 250 H, CP 300 H, V 350 H, V 6/8 H, V 7/8 H, V 65 HT, V 200 H

The Ni-MH Button Cells from **VARTA** Microbattery have certification for non-hazardous failure in the event of misuse or abuse such as:

- + Charging at an excessively high rate
- + Excessive reverse charge
- + Short circuiting
- + Exposure to open flame
- + Crushing

ISO 9001 + ISO 14001 CERTIFICATION

The quality system of sealed rechargeable button cell and battery production from **VARTA** Microbattery is certified to ISO 9001 and ISO 14001. That means besides production also administration/management and R&D are continuously involved in defined improving processes regarding to changing market needs.

ECOLOGICAL AWARD

VARTA Microbattery gets the ecological award "Gläserner Baum 1998" of the German retail with its cadmium free Ni-MH Button Cells.

LEAD-FREE SOLDERING

SINCE 2003, **VARTA** Microbattery has successfully implemented lead-free soldering for all Ni-MH Button Cell assemblies. Under RoHS*, lead is one of the hazardous substances which will be banned from use by 2006.

* Restriction of the use of certain Hazardous Substances in electrical and electronics equipments

application. Our Ni-MH Button Cells are highly environmentally compatible due to an innovative Pb-, Hg- and Cd-free design.



Trademark of Underwriters Laboratories

CUSTOMERS

Various well-known companies from all kinds of electrical and electronics industries are our satisfied customers over many years.

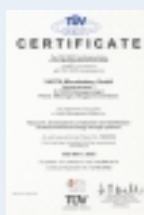

EC-Directive for batteries is fulfilled (Council Directive 91/157/EEC)

4.2 RELIABILITY AND LIFE EXPECTANCY

VARTA Microbattery Ni-MH Button Cells/Batteries are safe in normal usage and under anticipated conditions of unintentional abuse. Protective devices are incorporated into the cell/batteries to ensure maximum safety. For confirmation of product safety extensive testing of

typical abusive conditions has been performed. Features of the high reliability and long operating time at various applications are listed below and in Fig. 22, 23 and 24:

- + Long life expectancy:
 - + Cycle application (IEC): up to 1,000 cycles
 - + At trickle charge: up to 6 years at +20°C, up to 3 years at +45°C (up to 5 years at +45°C: V 65 HT, V 110 HT)
- + Wide temperature range for standard, high temperature and trickle charge applications
- + High overcharge capability for simple, inexpensive charging circuits
- + Excellent cell balance for robustness and high reliability

FIG. 22

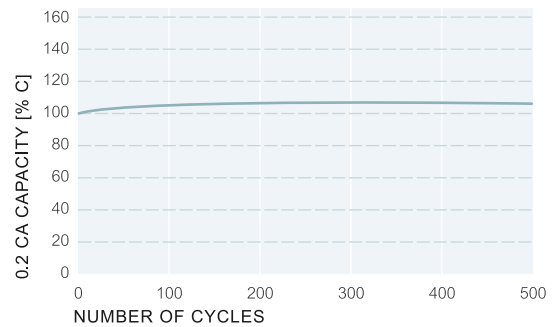

Cycling test by IEC 61951-2

FIG. 23

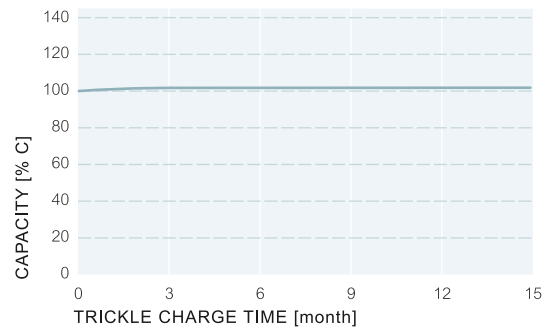

Trickle charge test at 45°C of Ni-MH Button Cells (trickle charge at 0.03 CA)

FIG. 24

Bridge battery life cycle test of V 80 H cell (bridging application)

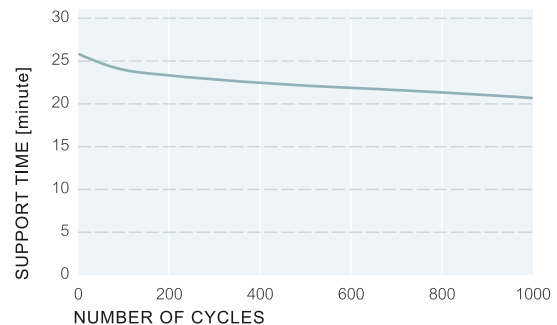

Cycling Method:
 Charge: 14 mA for 50 min.
 Discharge: 100 mA, for 5 min.
 Support Time:
 Discharge Time at 100 mA to 0.9 V per cell.
 Requirement: Support Time > 5 min.

4.3 HANDLING AND SAFETY GUIDELINES

Ni-MH cells are sealed designs which are maintenance free. These products may be used in any operating position. They should be kept clean and dry during storage and operation.

Normally shipped batteries or cells are in a charged

state. Therefore caution should be exercised not to short-circuit during transportation. Cells or batteries must be charged before use to obtain full capacity. In order to ensure performance expectations, the following conditions for use and handling are recommended.

CHARGING

Charging should be conducted as previously described in "Charging Methods" (see pages 14/15). Extended charging outside specified temperature ranges (see page 20) may have an adverse effect on cell life. Also permanent charging at the limits of specified temperature ranges may reduce the battery life. The maximum life is achieved, when charging at a temperature of 20°C to 30°C.

DISCHARGING

The specified temperature range is from -20°C to +65°C resp. +80°C on discharge. Repeated discharges at the extreme temperatures may affect battery life. In all applications do not deep-discharge (< 0.6 V/cell) or discharge into reverse our Ni-MH cells and batteries.

SAFETY GUIDELINES

- + Keep out of the reach of children. If swallowed, contact a physician at once
- + Do not incinerate or mutilate, may burst or release toxic materials
- + Do not short circuit, may cause burns
- + Do not deep-discharge or discharge into reverse
- + Do not solder on the battery directly (use our tagged versions)
- + Restrict charging current and time to the recommended value
- + Observe charging temperature: 0 to +65°C /+80°C
- + Battery compartment should provide sufficient space for battery to expand in case of abuse
- + Either battery compartment or battery connector should have a design that makes it impossible to place the battery in reverse polarity
- + Equipment intended for use by children should have tamper-proof battery compartment
- + Battery of different electrochemical system, grades, or brands should not be mixed
- + Battery disposal method should be in accordance with local and state regulations

4.4 BATTERY ASSEMBLY

CONNECTION AND TERMINALS

Never solder onto cells directly! Soldering of lead wires directly onto cells can damage the internal components like the sealing ring and other parts. It is recommended that a tag is spotwelded to the cell, on which lead wires can then be soldered.

PARALLEL CELL CONFIGURATION

Never connect cells in parallel during charging!

Parallel charging may produce unpredictable current distribution into cells. Therefore overcharge and low performing cells may result.

Parallel discharging may result in discharging of one cell to another. Therefore, it is necessary to use blocking diodes between cells connected in parallel on discharging. When designing a battery where paralleling is needed, please consult us.

DISASSEMBLY

Under no conditions should cells be disassembled. Cells contain potassium hydroxide electrolyte, which can cause injury. In the event that the electrolyte gets on skin or in eyes, immediately flush with water and seek medical advice.

INCINERATION

Do not put cells or batteries in fire!

MIXING OF CELL TYPES

Do not put different cells and capacities in the same battery assembly!

The mixed use of Ni-MH cells with Ni-Cd cells, primary cells, old and new cells, cells of different sizes and capacities in one assembly can lead to either battery damage or poor performance of the device that it is intended to power.

CONTACT MATERIALS

Battery assembly contact materials as well as contacts in battery holders should have a nickel surface for best corrosion resistance.

BATTERY POSITION IN DEVICES

For optimum life batteries should be shielded or placed apart from heat sources.

HANDLING

Do not pull excessively on lead wires or connectors, as excessive force will cause product damage.

VENTED BATTERY COMPARTMENTS

Airtight battery compartments should be avoided. Under abuse conditions cell venting may occur releasing hydrogen gas. It is therefore necessary for compartments to have an air ventilation.

4.5 STORAGE / HANDLING

Sealed rechargeable Ni-MH Button Cells from **VARTA** Microbattery can be operated in any position. Maintenance of the cells is not necessary, they are maintenance-free. However, the cells, like other electrical components, should be kept clean and dry. The cells complete the manufacturing process in a charged state. A considerable period of time can elapse due to assembly into battery units, storage and dispatch before they are taken into service by the customer. Because of time and temperature depending self-discharge, the state of charge upon receipt can not be precisely defined. Before use, therefore, sealed Ni-MH cells should be recharged.

To ensure long life and trouble-free operation, charging should be carried out as previously advised. Sealed Ni-MH cells can be stored for a long time without permanently losing capacity. Before storage the cells should be fully charged and must be disconnected from any load. The most advantageous storage temperatures are between 10 and +35°C, at a relative humidity of approx. 50%. Cells should be protected from moisture and contamination.

Before putting into operation, stored cells should be recharged for 24 hours at the nominal charge rate or at a smaller current for a longer time. An extended charge process or two or three normal reconditioning cycles are necessary after longer storage. In this way the cells are reactivated and will achieve their “full capacity” i.e. the activatable present capacity after storage again.

Direct soldering onto the cells can lead to damage. Ni-MH Button Cells/Batteries from **VARTA** Microbattery are available with different connectors, e.g. ring solder tags, solder lugs and plug solder lugs for printed circuits.

Button cells and button cell batteries for printed circuit board solder application can be flow soldered in the charged state as long as the soldering time does not exceed 10 secs. The preheating period should also be limited to approx. 10 secs. The specified temperature limits should also be observed with the “Burn-in” tests. Consult **VARTA** Microbattery with regard to the compatibility of cleaning materials for printed circuit boards.

For Ni-MH Button Cells from **VARTA** Microbattery there are no restrictions regarding to their operating positions.

In general, referring to Ni-MH batteries – as for any battery – please remember:

- + Do not short-circuit
- + Do not damage
- + Do not incinerate
- + Do not handle out of specification
- + Keep out of reach of children. If swallowed, contact a physician at once

4.6 DEFINITIONS

BASICALLY

Unless otherwise stated the technical values and definitions are based on room temperature conditions (R. T. = 20°C ± 2°C).

SYSTEM – SPECIFIC DATA

The gravimetric energy density of the Ni-MH system depends on battery size and ranges from approx. 40–55 Wh/kg and the volumetric energy density ranges from approx. 120–180 Wh/l.

VOLTAGE DEFINITIONS

Open Circuit Voltage (O.C.V.):

Equilibrium potential 1.25 V to 1.4 V on average, dependent on temperature, storage duration and state of charge.

Nominal Voltage of sealed Ni-MH button cells is 1.25 V.

End of Discharge Voltage (V_E):

The voltage at the end of discharging is 1.1 V to 0.9 V per cell, depending on discharge rate.

End of Charge Voltage:

Terminal voltage after charge of 14 to 16 hours at the nominal rate 0.1C A, about 1.45 V/cell at room temperature.

CAPACITY DEFINITIONS

The Capacity C

of a cell is defined by the discharge current I and the discharge time t:

$$C = I \cdot t$$

I = constant discharge current

t = duration from the beginning of discharge until the end of discharge voltage is reached.

Nominal Capacity

The nominal capacity C denotes in quantity of electricity in mAh (milli-Ampère hours) that the cell can deliver at the 5 h discharge rate (0.2C A). The reference temperature is 20°C ± 2°C, and the final discharge voltage 1.0 V.

Typical Capacity:

The typical capacity is the average capacity at a discharge rate of 0.2 CA to a final discharge voltage of 1.0 V.

Available Capacity:

Ni-MH cells deliver their nominal capacity at 0.2 CA. This assumes that charging and discharging is carried out as recommended. Factors which affect the available capacity are:

- + Rate of discharge
- + End of discharge voltage
- + Ambient temperature
- + State of charge

At higher than nominal discharge rates the available capacity is correspondingly reduced.

CURRENT DEFINITIONS

Charge and discharge rates are given as multiples of the nominal capacity (C) in ampères (A) with the term CA. Example:

Nominal capacity C = 100 mAh
0.1 CA = 10 mA, 1 CA = 100 mA

Nominal Charge Current:

The nominal charge current is the charge rate (0.1 CA) which is necessary to achieve full charge of a cell in 14 to 16 hours, if the cell has been fully discharged.

Overcharge Current:

Overcharge of 0.1 CA continuously is possible. Permissible current 0.2 CA for occasional overcharging not exceeding 1 year. Frequent overcharge reduces cell/battery life. Overcharge is restricted to room temperature.

Permanent Charge Current:

Recommended current 0.03 CA for capacity retention (also known as trickle charge current).

Nominal Discharge Current:

The nominal discharge current of a Ni-MH cell is the 5 hour discharge current (0.2 CA). It is current at which the nominal capacity of a cell is discharged in 5 hours.

$$I = \frac{C}{t} = \frac{C}{5} = 0.2 \text{ CA when } t = 5 \text{ h}$$

AH-EFFICIENCY

The ratio of effective available capacity and capacity input is denoted as charge efficiency.

$$\eta_{Ah} = \frac{\text{available capacity}}{\text{capacity input}}$$

η_{Ah} is dependent on cell type, charge rate, cell temperature and discharge rate. In case of nominal conditions maximum η_{Ah} value is approximately 0.8, that means at least 125% charge input of nominal capacity is necessary. In practice a charge input of 140 to 160% at the nominal charge current is recommended.

4.7 APPLICATION PROJECT CHECK LIST

+ CUSTOMER:

Volume cells per year: _____

Target Price: _____

Min. operating voltage V_B : _____ (V)

Operating time required: _____ Hours: _____

+ APPLICATION:

Samples requested: _____

Delivery required: _____

Max. V_B _____ (V)

Days: _____ Month: _____

+ DISCHARGE conditions at: Min. temperature: _____ (°C)

Max. temperature: _____ (°C)

Discharge mode	(A)	(mA)	Operating time	Per discharge		
Continuous discharge	_____	_____	_____	Pulse number		
Pulse discharge	_____	_____	_____	Min.	Hr.	Days
Max. current	_____	_____	_____	<input type="checkbox"/>	<input type="checkbox"/>	<input type="checkbox"/>
Min. current	_____	_____	_____	<input type="checkbox"/>	<input type="checkbox"/>	<input type="checkbox"/>

+ CHARGE CONDITIONS AT: Min. temperature: _____ (°C)

Max. temperature: _____ (°C)

Required charge method:

Standard charge Accelerated charge Limited fast charge Trickle charge

Preferred charge termination method: _____

Available charging current: _____

Charge time available: _____ Minutes: _____ Hours: _____ Days: _____

Further information on charging: _____

+ CONSTRUCTIONAL AND MECHANICAL REQUIREMENTS:

Space available: _____ Length: _____ (mm) x Width: _____ (mm) x Height: _____ (mm)

Requested battery type _____ Type of battery form: _____

_____ Type of terminals: _____

Qualification test procedures of the customer: _____

VARTA Microbattery

mobility for you

GLOBAL CONTACTS

Germany

VARTA Microbattery GmbH
Daimlerstraße 1
73479 Ellwangen, Germany
Tel (+49) 79 61 921 - 0
Fax (+49) 79 61 921 - 553

Asia Pacific

VARTA Microbattery Pte. Ltd.
300, Tampines Avenue 5, #05-01,
Tampines Junction, 529653 Singapore
Tel (+65) 6 260 58 01
Fax (+65) 6 260 58 12

China

Hongkong
VARTA Microbattery Pte. Ltd.
Rm. 1702-3, 17/F., Fullerton Centre,
19 Hung to Road, Kwun Tong,
Kowloon, Hongkong
Tel (+852) 28 98 83 73
Fax (+852) 28 97 76 09

Beijing

VARTA Microbattery Pte. Ltd.
Kun Tai Building, Unit 1202,
No. 10 Chao Wai
Post Code 100020, Beijing, China
Tel (+86) 10 6599 5277
Fax (+86) 10 6599 5279

Shanghai

VARTA Microbattery Pte. Ltd.
Block 3, Shanghai Pudong, Chuansha Industrial Park,
No. 6999 Chuansha Road, Pudong New Area,
201202 Shanghai, China
Tel (+86) 21 5859 3312
Fax (+86) 21 5859 3313

Japan

VARTA Microbattery Pte. Ltd.
1-6-12 Kyobashi, chuo-ku,
Tokyo 104-0031, Japan
Tel (+81) 3 - 35 67 - 81 71
Fax (+81) 3 - 35 67 - 81 75

South Korea

VARTA Microbattery Pte. Ltd.
411-1 KCAT Bldg.,
159-6 Samsung-dong, Kangnam-gu,
Seoul 135-728 Korea
Tel (+82) 2 - 551 5345
Fax (+82) 2 - 551 5344

Taiwan

VARTA Microbattery Pte. Ltd.
200 A Room, 2/F World Trade Building 50,
Hsin Shen S. Rd., Section 1
Taipei 100, Taiwan
Tel (+886) 2 - 33 93 15 57
Fax (+886) 2 - 33 93 15 56

Scandinavia and Finland

VARTA Microbattery Nordic
Langebjergvaenget 8 B,
1. Tv. DK - 4000 Roskilde, Denmark
Tel (+45) 2424 8000
Fax (+45) 4675 0150

America

VARTA Microbattery, Inc.
1311 Mamaroneck Avenue, Suite 120,
White Plains, NY 10605, USA
Tel (+1) 914 - 592 25 00
Fax (+1) 914 - 345 04 88

UK and Ireland

VARTA Microbattery GmbH
16 Progress Business Centre,
Whittle Parkway, Slough SL1 6DQ, GB
Tel (+44) 1628 - 60 7930
Fax (+44) 1628 - 60 7939

France

VARTA Microbattery SARL
12-14, Rue Raymond RIDEL,
92250 La Garenne Colombes, France
Tel (+33) (0) 1 - 4784 8454
Fax (+33) (0) 1 - 4784 2832

Italy

VARTA Microbattery Italia
Stradone S. Fermo, 19,
37121 Verona, Italy
Tel (+39) 045 - 8 00 16 15
Fax (+39) 045 - 59 18 78

Distributors

Distributors and representations in all major countries world wide. Consult our Webpage.

Internet

For e-mail contact please visit:
For more information please visit our website:

<http://contact.varta-microbattery.com>
www.varta-microbattery.com



VARTA Microbattery – Technology Portfolio

Primary systems

- Lithium Polymer (CardPower)
- Silver oxide
- Alkaline
- Lithium
- H₂ Hydrogen generating cell
- O₂ Oxygen sensor cell
- Zinc Air

Secondary systems

- Lithium Polymer
(VARTA PoLiFlex®)
- Nickel-Metal-Hydride
- Lithium-Ion

Our trademarks  **VARTA** and  **powerone** are distributed world wide with support of our technically skilled, professional global sales and service network.

 **VARTA**